

● General Description

This silicon carbide Power MOSFET device has been developed using ZMJ’s advanced 2<sup>nd</sup> generation SiC MOSFET technology. The device features a very low  $R_{DS(on)}$  over the entire temperature range combined with low capacitances and very high switching operations. It improves application performance in frequency, energy efficiency, system size and weight reduction.

● Features

- High Blocking Voltage
- High Speed Switching With Low Capacitances
- Low  $R_{DS(on)}$  to Minimize Conductive Loss
- Low Gate Charge For Fast Switching
- Low Thermal Resistance
- 100% Avalanche Tested
- AEC-Q101 Qualified

● Application

- Motor Drives
- On Board Charger
- DC-DC
- Auxiliary Drives

● Product Summary

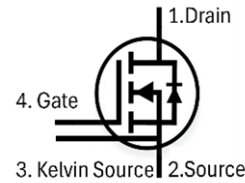

$V_{DS} = 1200V$   
 $R_{DS(ON)} = 53m\Omega$   
 $I_D = 35A$

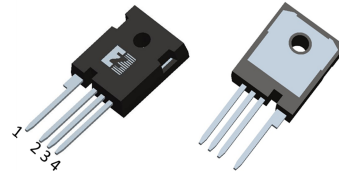

TO-247-4



● Ordering Information:

Part NO.	ZMCA060N120C4
Marking	ZMC060N120
Packing Information	BULK TUBE
Basic Ordering Unit (pcs)	600

● Absolute Maximum Ratings ( $T_C=25^\circ C$ )

Parameter	Symbol	Conditions	Value	Unit
Drain-Source Voltage	$V_{DS}$		1200	V
Gate-Source Voltage	$V_{GS}$	Transient Voltage	-10V/25V	V
	$V_{GS}$	Static Voltage	-10V/24V	V
Recommended Turn On Gate Voltage	$V_{GS(on)}$		15 to 18V	V
Recommended Turn Off Gate Voltage	$V_{GS(off)}$		-4V to 0V	V
Continuous Drain Current	$I_D$	$T_C=25^\circ C$	35	A
	$I_D$	$T_C=75^\circ C$	28	A
	$I_D$	$T_C=100^\circ C$	24	A

Pulsed Drain Current <sup>①</sup>	$I_{DM}$	Pulsed; $t_p \leq 10 \mu s$ ; $T_{mb} = 25^\circ C$ ;	140	A
Total Power Dissipation	$P_D$	$T_C = 25^\circ C$	197	W
Total Power Dissipation	$P_D$	$T_A = 25^\circ C$	3.8	W
Operating Junction Temperature	$T_J$		-55 to +175	$^\circ C$
Storage Temperature	$T_{STG}$		-55 to +175	$^\circ C$
Single Pulse Avalanche Energy	$E_{AS}$	$L=0.5mH, V_{GS}=18V, R_g=25\Omega$	361	mJ
ESD Level (HBM)			Class2	

### • Thermal Resistance

Parameter	Symbol	Min.	Typ.	Max.	Unit
Thermal Resistance, Junction - Case	$R_{thJC}$	-	-	0.76	$^\circ C/W$
Thermal Resistance, Junction-Ambient	$R_{thJA\oplus}$	-	-	40	$^\circ C/W$
Soldering Temperature(total time<10s)	$T_{sold}$	-	-	260	$^\circ C$

### • Electronic Characteristics

Parameter	Symbol	Condition	Min.	Typ.	Max.	Unit
Drain-Source Breakdown Voltage	$BV_{DSS}$	$V_{GS} = 0V, I_D = 250\mu A$	1200	-	-	V
Gate Threshold Voltage	$V_{GS(TH)}$	$V_{GS} = V_{DS}, I_D = 5mA$	2	2.8	4	V
Drain-Source Leakage Current	$I_{DSS}$	$V_{GS} = 0V, V_{DS} = 1200V$	-	-	10	$\mu A$
Gate- Source Leakage Current	$I_{GSS}$	$V_{GS} = -10V, V_{DS} = 0V$	-	-	-100	nA
		$V_{GS} = 25V, V_{DS} = 0V$	-	-	100	nA
Static Drain-Source On Resistance	$R_{DS(on)}$	$T_J = 25^\circ C, V_{GS} = 18V, I_D = 20A$	-	53	65	m $\Omega$
		$T_J = 175^\circ C, V_{GS} = 18V, I_D = 20A$	-	110	-	m $\Omega$
		$T_J = 25^\circ C, V_{GS} = 15V, I_D = 20A$	-	63	-	m $\Omega$
Forward Transconductance	$g_{fs}$	$V_{DS} = 10V, I_{SD} = 20A$	-	8.5	-	S
Diode Forward Voltage	$V_{FSD}$	$V_{GS} = -4V, I_{SD} = 20A$	-	4.3	5	V

### • Dynamic Characteristics

Parameter	Symbol	Condition	Min.	Typ.	Max.	Unit
Input Capacitance	$C_{iss}$	$f = 100KHz, V_{DS} = 800V$	-	1690	-	pF
Output Capacitance	$C_{oss}$		-	67	-	
Reverse Transfer Capacitance	$C_{rss}$		-	3	-	
Output Charge	$Q_{oss}$	$f = 100KHz, V_{GS} = 0V, V_{DS} = 0V \text{ to } 800V$	-	90	-	nC
Coss Stored Energy	$E_{oss}$		-	25	-	$\mu J$
Gate Resistance	$R_g$	$f = 1MHz$	-	1.7	-	$\Omega$
Total Gate Charge	$Q_g$	$V_{DD} = 800V, I_D = 20A, V_{GS} = -4V/18V$	-	69	-	nC
Gate - Source Charge	$Q_{gs}$		-	23	-	
Gate - Drain Charge	$Q_{gd}$		-	26	-	

Turn-ON Delay Time	$t_{D(on)}$	$V_{GS}=-4V/18V, V_{DS}=800V,$ $R_G=10\Omega, I_D=20A,$ $L=505\mu H$	-	13	-	ns
Turn-ON Rise Time	$t_r$		-	4.2	-	ns
Turn-Off Delay Time	$t_{D(off)}$		-	34	-	ns
Turn-Off Fall Time	$t_f$		-	15	-	ns
Turn-On Energy	$E_{on}$		-	580	-	$\mu J$
Turn-Off Energy	$E_{off}$		-	156	-	$\mu J$
Reverse Recovery Time	$t_{rr}$	$V_{DD}=800V, di_S/dt =$ $600A/\mu s, I_S=20A$	-	24	-	ns
Reverse Recovery Peak Current	$I_{rrm}$		-	5.5	-	A
Reverse Recovery Charge	$Q_{rr}$		-	74	-	nC

● Characteristics Diagrams

Fig.1 Gate-Charge Characteristics

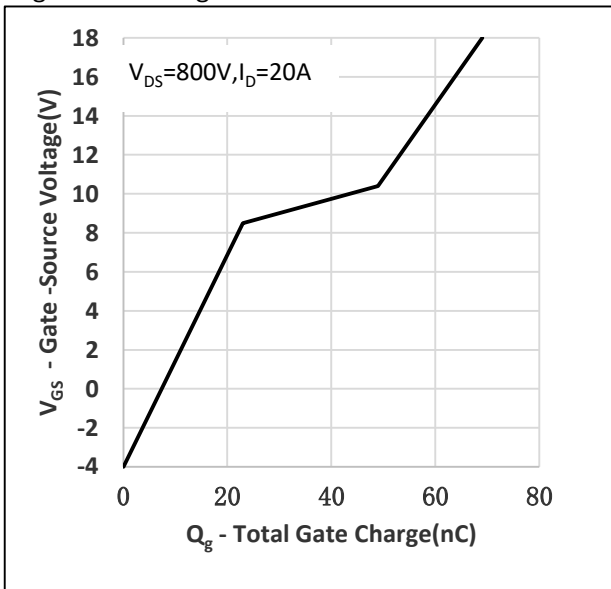

Fig.2 Capacitance Characteristics

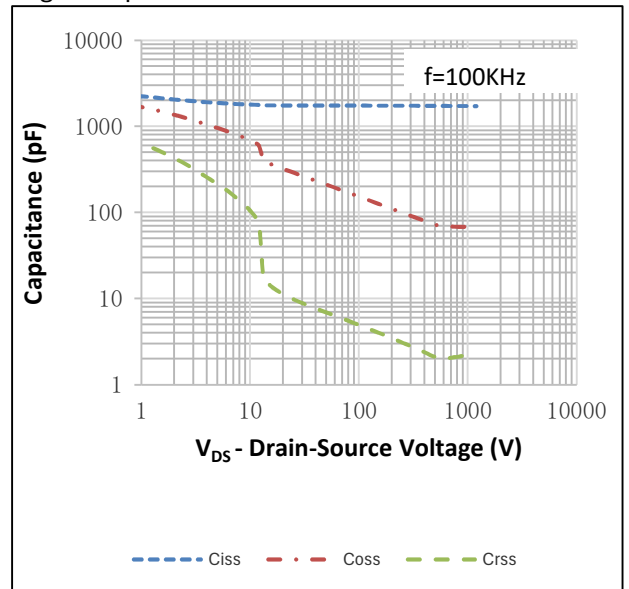

Fig.3 Power Dissipation

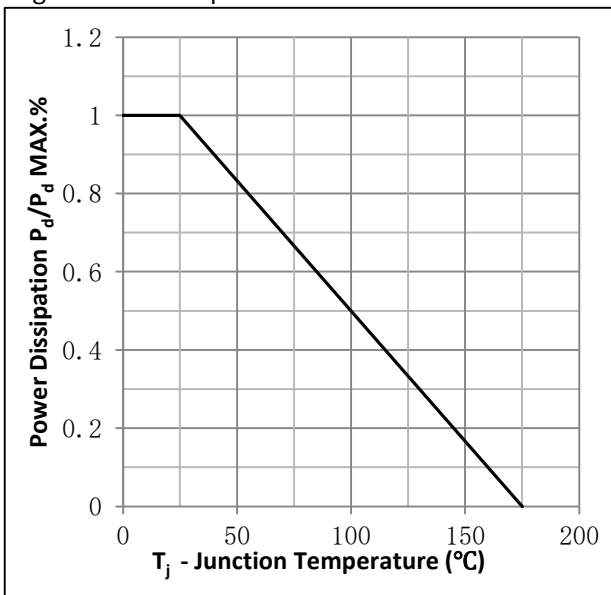

Fig.4 Typical Output Characteristics

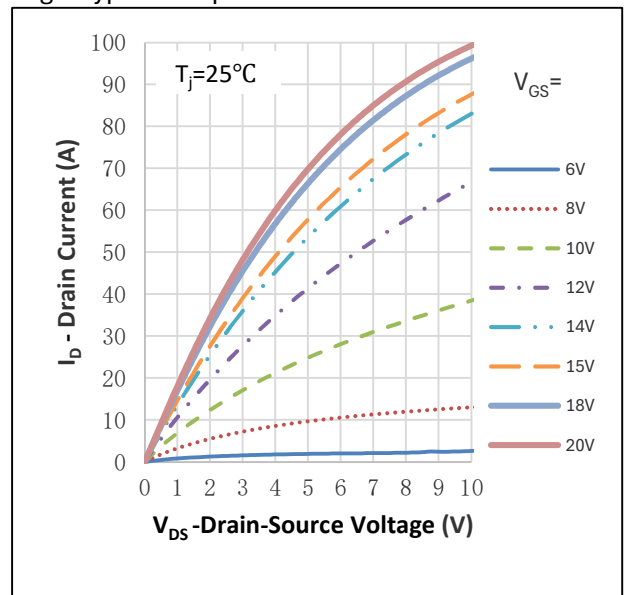

Fig.5 Threshold Voltage vs. Junction Temperature

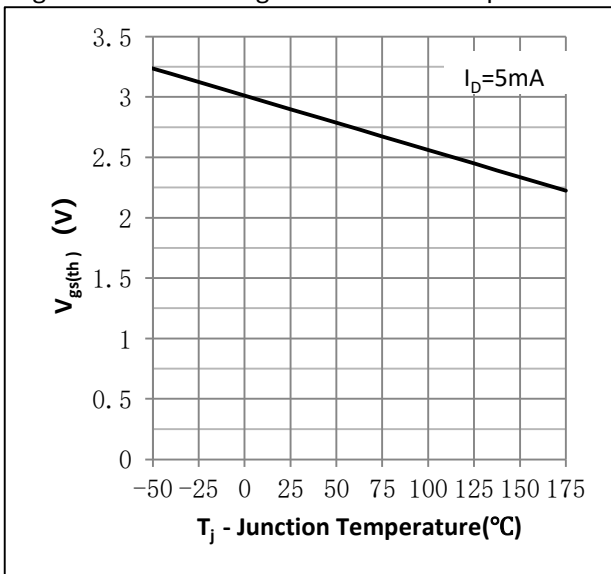

Fig.6 On-Resistance vs. Drain Current

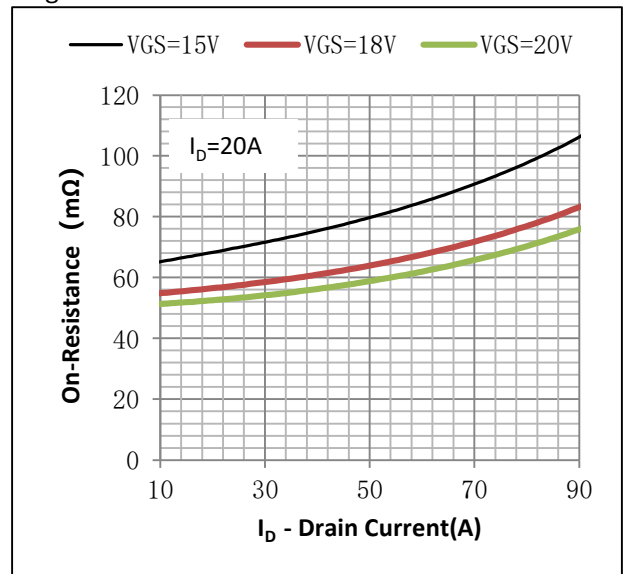

Fig.7 On-Resistance vs. Gate Source Voltage

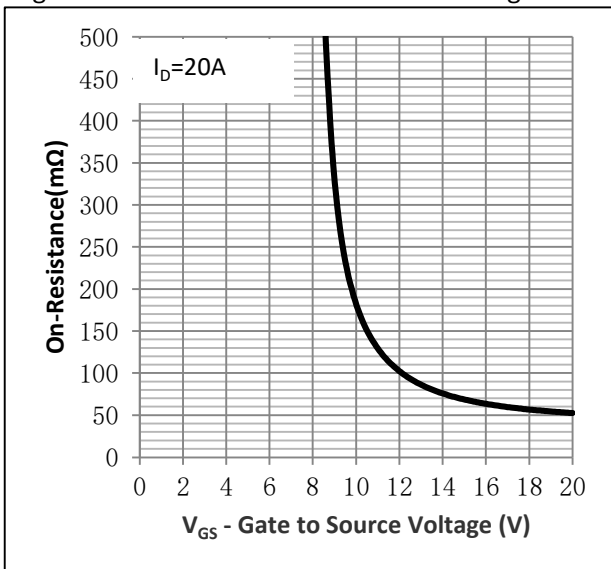

Fig.8 On-Resistance vs. Junction Temperature

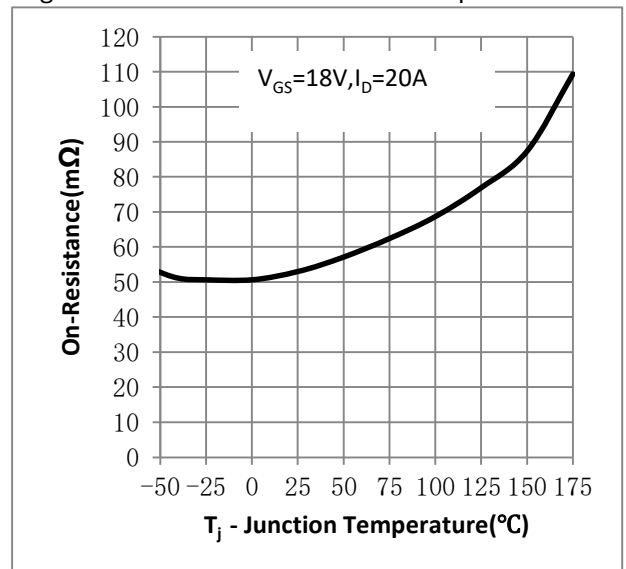

Figure 9. Diode Forward Voltage vs. Current

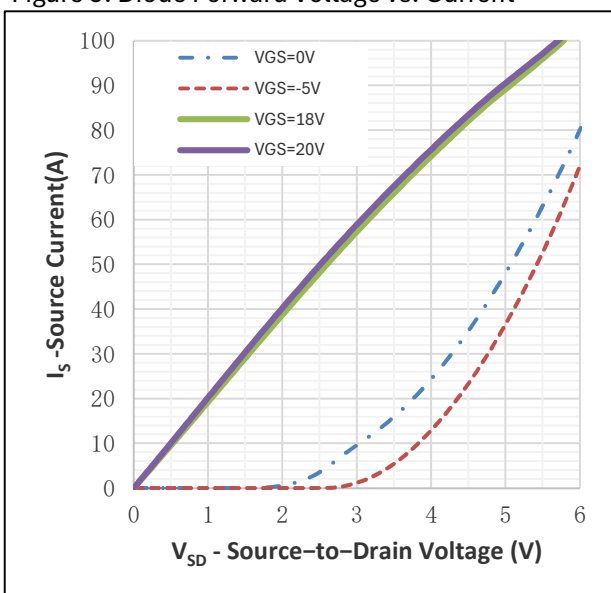

Figure 10. Transfer Characteristics

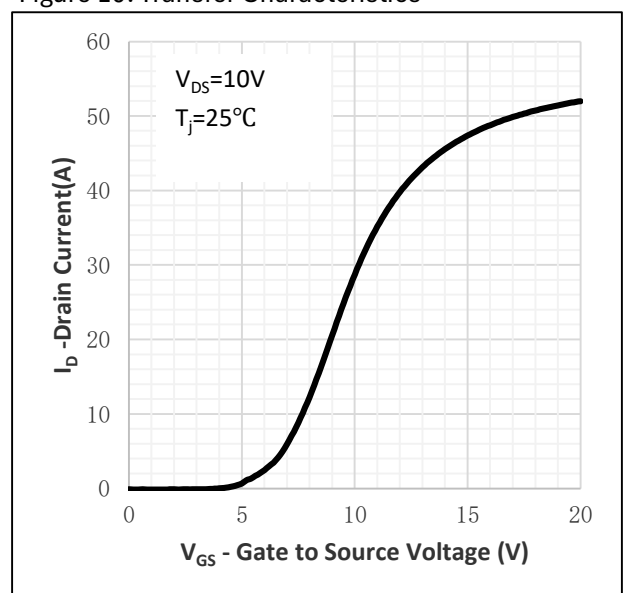

Fig.11 SOA Maximum Safe Operating Area

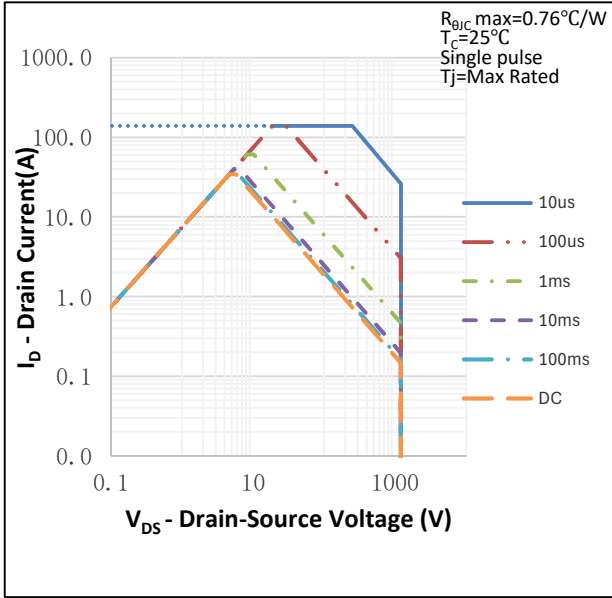

Fig.12  $I_D$  vs. Junction Temperature

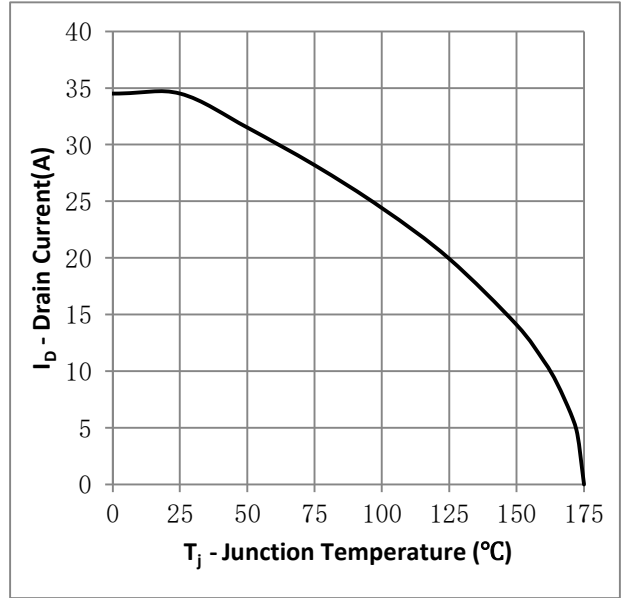

Fig.13 Output Capacitor Stored Energy

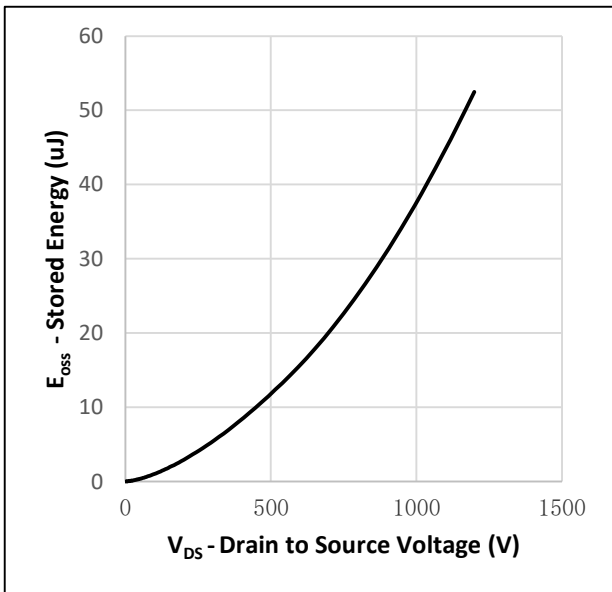
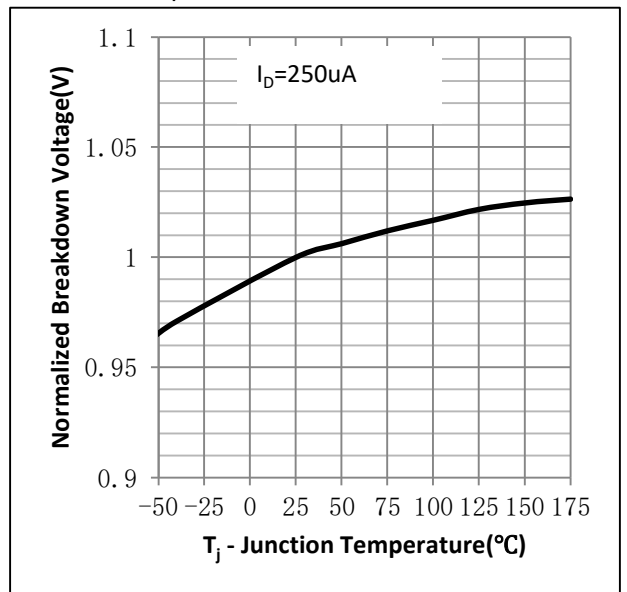
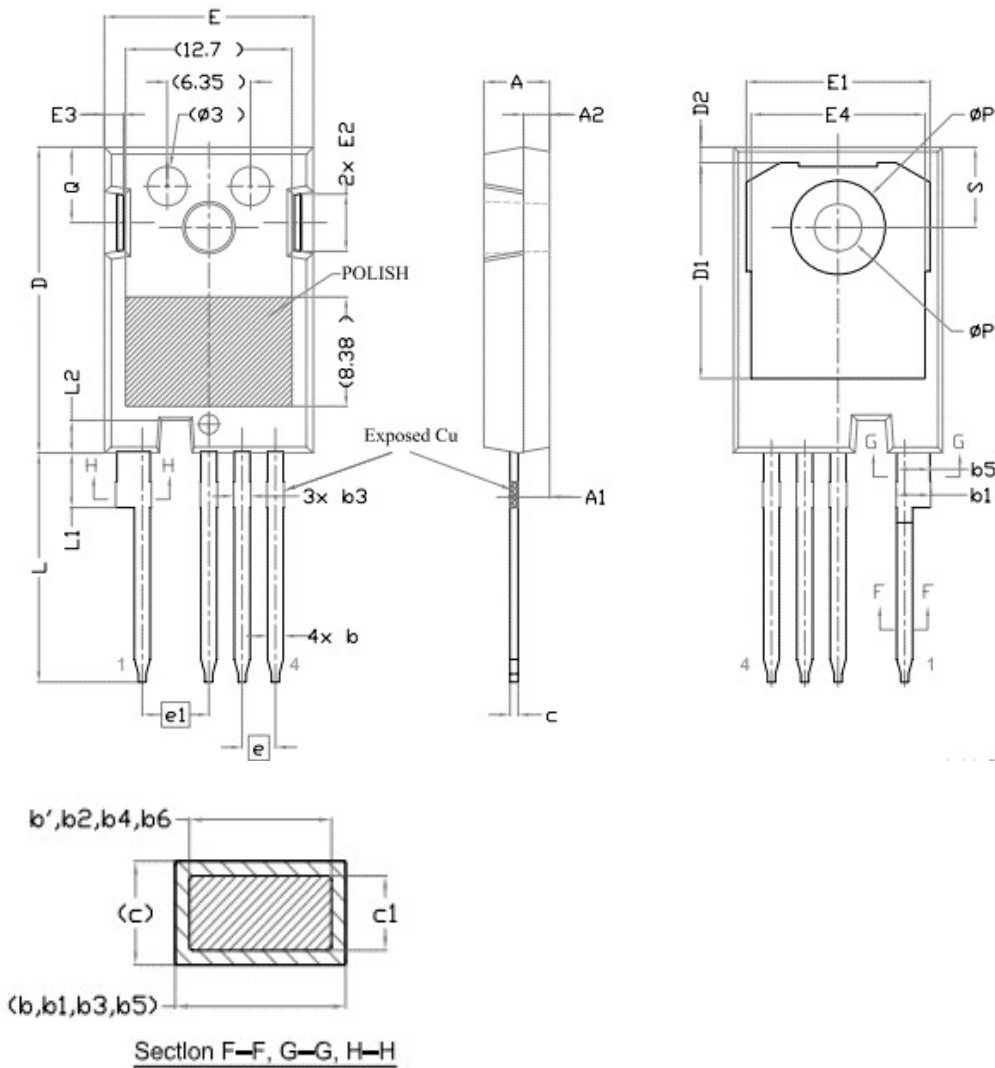

Fig.14 Normalized Breakdown Voltage vs. Junction Temperature



•TO-247-4 Package Outline



SYMBOL	DIMENSIONS		
	MIN.	NOM.	MAX.
A	4.83	5.02	5.21
A1	2.29	2.41	2.54
A2	1.91	2.00	2.16
b'	1.07	1.20	1.28
b	1.07	1.20	1.33
b1	2.39	2.67	2.94
b2	2.39	2.67	2.84
b3	1.07	1.30	1.60
b4	1.07	1.30	1.50
b5	2.39	2.53	2.69
b6	2.39	2.53	2.64
c	0.55	0.60	0.68
c1	0.55	0.60	0.65
D	23.30	23.45	23.60
D1	16.25	16.55	17.65
D2	0.95	1.19	1.25
E	15.75	15.94	16.13
E1	13.10	14.02	14.15
E2	3.68	4.40	5.10
E3	1.00	1.45	1.90
E4	12.38	13.26	13.43
e	2.54 BSC		
e1	5.08 BSC		
L	17.31	17.57	17.82
L1	3.97	4.19	4.37
L2	2.35	2.50	2.65
∅P	3.51	3.61	3.65
∅P1	7.19 REF.		
Q	5.49	5.79	6.00
S	6.04	6.17	6.30

**Note:**

- ① The value of  $R\theta JA$  is measured with the device in a still environment with  $T_A=25^\circ C$
- ② Practically the current will be limited by PCB, thermal design and operating temperature.  $V_{GS}=18V$ .

**Disclaimer**

- Reproducing and modifying information of the document is prohibited without permission from ZMJ SEMICONDDUCTORS CO.,LTD.
- ZMJ SEMICONDDUCTORS CO.,LTD. reserves the rights to make changes of the content herein the document anytime without notification. Please refer to our website for the latest document.
- ZMJ SEMICONDDUCTORS CO.,LTD. disclaims any and all liability arising out of the application or use of any product including damages incidentally and consequentially occurred.
- ZMJ SEMICONDDUCTORS CO.,LTD. does not assume any and all implied warranties, including warranties of fitness for particular purpose, non-infringement and merchantability.
- Applications shown on the herein document are examples of standard use and operation. Customers are responsible in comprehending the suitable use in particular applications. ZMJ SEMICONDDUCTORS CO.,LTD. makes no representation or warranty that such applications will be suitable for the specified use without further testing or modification.
- The products shown herein are not designed and authorized for equipments relating to human life and for any applications concerning life-saving or life-sustaining, such as medical instruments, aerospace machinery et cetera. Customers using or selling these products for use in such applications do so at their own risk and agree to fully indemnify ZMJ SEMICONDDUCTORS CO.,LTD. for any damages resulting from such improper use or sale.
- Since ZMJ uses lot number as the tracking base, please provide the lot number for tracking when complaining.

**Revision History:**

Version	Date	Change
A	2024/6/7	New
B	2024/7/8	Correct Fig.8, update switching and reverse recovery result.
C	2024/11/22	Update VGS maximum rating and IGSS+ test condition.